

TECHNICAL SPECIFICATION - TRUCHECK™ 2

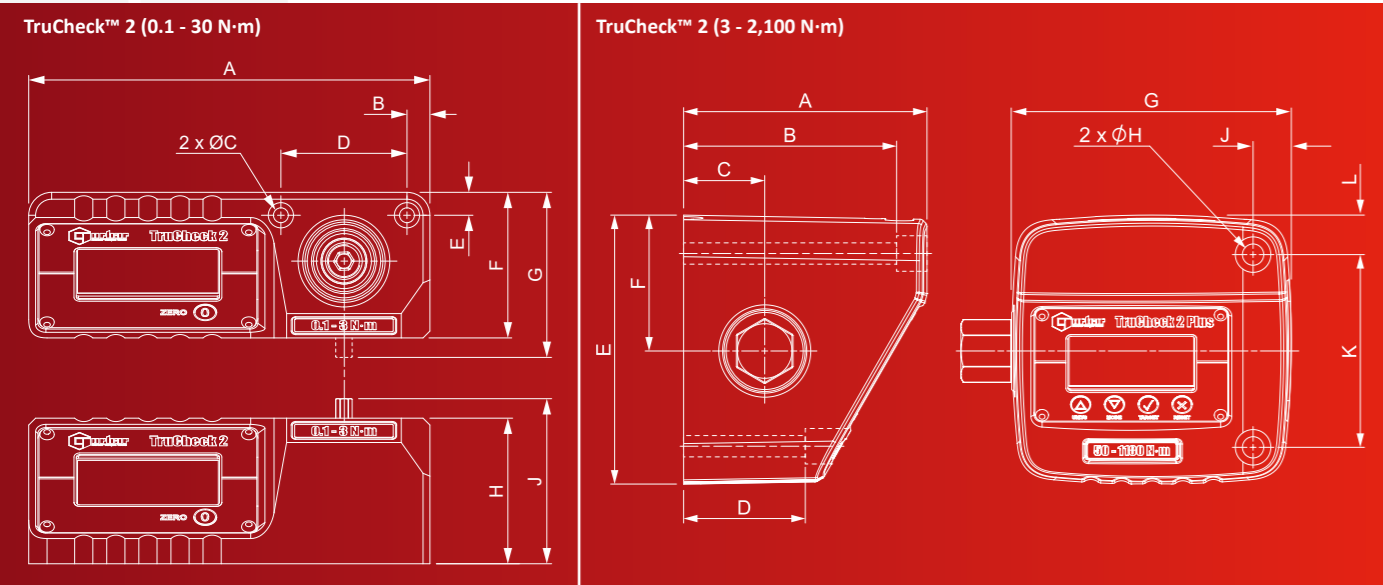

PART NUMBER	MODEL	IN-BUILT TRANSDUCER MALE HEX/FEMALE SQ. DR.	DIMENSIONS (mm)											WEIGHT (kg)
			A	B	ØC / C	D	E	F	G	H / ØH	J	K	L	
43514	TruCheck 2, 0.1 - 3 N-m	1/4" male hex & 1/4" female sq. dr. adapter	175	10	6.5	55	10	64	N/A	64	72	N/A	N/A	1.4
43515	TruCheck 2 Plus, 0.1 - 3 N-m	1/4" male hex & 1/4" female sq. dr. adapter	175	10	6.5	55	10	64	N/A	64	72	N/A	N/A	1.4
43516	TruCheck 2, 0.5 - 10 N-m	1/4" male hex & 1/4" female sq. dr. adapter	175	10	6.5	55	10	64	N/A	64	72	N/A	N/A	1.4
43517	TruCheck 2 Plus, 0.5 - 10 N-m	1/4" male hex & 1/4" female sq. dr. adapter	175	10	6.5	55	10	64	N/A	64	72	N/A	N/A	1.4
43518	TruCheck 2, 1.5 - 30 N-m	10 mm male hex, 1/4" & 3/4" female sq. dr. adapter	175	10	6.5	55	10	64	72	64	N/A	N/A	N/A	1.4
43563	TruCheck 2 Plus, 1.5 - 30 N-m	10 mm male hex, 1/4" & 3/4" female sq. dr. adapter	175	10	6.5	55	10	64	72	64	N/A	N/A	N/A	1.4
43520	TruCheck 2, 3 - 65 N-m	3/4" female sq. dr.	110	95	40	50	117	59	138	10.5	19	80	19	2.6
43521	TruCheck 2 Plus, 3 - 65 N-m	3/4" female sq. dr.	110	95	40	50	117	59	138	10.5	19	80	19	2.6
43522	TruCheck 2, 10 - 260 lbf-ft	1/2" female sq. dr.	110	95	40	50	117	59	138	10.5	19	80	19	2.6
43523	TruCheck 2 Plus, 10 - 260 lbf-ft	1/2" female sq. dr.	110	95	40	50	117	59	138	10.5	19	80	19	2.6
43524	TruCheck 2, 10 - 350 N-m	1/2" female sq. dr.	110	95	40	50	117	59	138	10.5	19	80	19	2.6
43525	TruCheck 2 Plus, 10 - 350 N-m	1/2" female sq. dr.	110	95	40	50	117	59	138	10.5	19	80	19	2.6
43528	TruCheck 2, 40 - 800 lbf-ft	27 mm male hex & 3/4" female sq. dr. adapter	120	105	40	60	133	67	138	10.5	19	95	20	3.5
43529	TruCheck 2 Plus, 40 - 800 lbf-ft	27 mm male hex & 3/4" female sq. dr. adapter	120	105	40	60	133	67	138	10.5	19	95	20	3.5
43530	TruCheck 2, 50 - 1,100 N-m	27 mm male hex & 3/4" female sq. dr. adapter	120	105	40	60	133	67	138	10.5	19	95	20	3.5
43531	TruCheck 2 Plus, 50 - 1,100 N-m	27 mm male hex & 3/4" female sq. dr. adapter	120	105	40	60	133	67	138	10.5	19	95	20	3.5
43532	TruCheck 2, 200 - 2,100 N-m	27 mm male hex & 1" female sq. dr. adapter	120	105	40	60	133	67	138	10.5	19	95	20	3.5
43533	TruCheck 2 Plus, 200 - 2,100 N-m	27 mm male hex & 1" female sq. dr. adapter	120	105	40	60	133	67	138	10.5	19	95	20	3.5

NOTE: The male hexagon on the 3 N-m and 10 N-m models is vertically aligned. The 30 N-m model male hexagon is horizontally aligned.



10 N-m model showing vertically aligned male hexagon (same as 3 N-m model)



30 N-m model showing horizontally aligned male hexagon



GLOBAL SERVICE

Norbar is the only torque equipment manufacturer capable of offering tool and instrument calibration services to the original factory standard on four continents.

Accredited laboratories in Australia, USA, Singapore, China and India operate the same equipment and procedures as the UKAS accredited laboratory within our headquarters in the UK.

 **NORBAR TORQUE TOOLS LTD**
Wildmere Road, Banbury, Oxfordshire, OX16 3JU
UNITED KINGDOM
Tel + 44 (0)1295 753600
Email sales@norbar.com

 **NORBAR TORQUE TOOLS**
45-47 Raglan Avenue, Edwardstown
SA 5039
AUSTRALIA
Tel + 61 (0)8 8292 9777
Email enquiry@norbar.com.au

 **NORBAR TORQUE TOOLS INC**
36400 Biltmore Place, Willoughby
Ohio 44094
USA
Tel + 1 866 667 2272
Email inquiry@norbar.us

 **NORBAR TORQUE TOOLS**
c/o Snap-on Tools Singapore PTE LTD
25 Tagore Lane #01-02
SINGAPORE 787 602
Tel + 65 6841 1371
Email enquiries@norbar.sg

 **NORBAR TORQUE TOOLS (SHANGHAI) LTD**
7/F, Building 91, No. 1122,
Qinzhou North Road
Xuhui District, Shanghai
CHINA 200233
Tel + 86 21 6145 0368
Email sales@norbar.com.cn











 **NORBAR TORQUE TOOLS INDIA PVT. LTD**
Plot No A – 168 Khairne Industrial Area
Thane Belapur Road
Mahape Navi Mumbai – 400 709
INDIA
Tel + 91 22 2778 8480
Email enquiry@norbar.in

www.norbar.com



Part number 07597 | Issue 3

NORBAR PRODUCT PORTFOLIO

-  Torque Screwdrivers
-  Torque Wrenches
-  Electronic Torque Wrenches
-  Manual Torque Multipliers
-  Pneumatic Torque Tools
-  Electronic Torque Tools
-  Battery Torque Tools
-  Torque Measurement Instruments
-  Torque Transducers
-  Ultrasonic Bolt Measurement
-  Calibration Services



TRUCHECK™ 2 SIMPLE, COST-EFFECTIVE TORQUE WRENCH CHECKING



Distributed by



IKEMA spol. s.r.o.
Tabaková 2
900 27 Bernolákovo
SLOVAKIA

tel.: +421 (2) 4599 4876
e-mail: ikema@ikema.sk
www.ikema.sk

© Norbar Torque Tools Ltd 2023
Printed in the UK

THIS COST-EFFECTIVE TORQUE WRENCH CHECKER HAS BEEN REDESIGNED TO INCORPORATE IMPROVED FEATURES WHILST MAINTAINING EASE OF USE. THE TRUCHECK™ 2 AIMS TO CUT THE COST OF PURCHASING A TORQUE WRENCH CHECKING SYSTEM AND REMOVE THE RESERVATIONS OVER THE COMPLEXITY OF USING SUCH EQUIPMENT.



Power Tool Test Fixture
 TruCheck™ 2 can also be used for checking non-impacting powered torque tools, such as the EvoTorque® Battery Tool as shown on the left. Norbar's Power Tool Test Fixture for use with TruCheck2 (#80033) will enable this cost-effective means of checking powered torque tools.

3 N-m and 10 N-m models supplied with ¼" male hexagon and a ¼" female square drive adapter

30 N-m models supplied with 10 mm male hexagon, ¼" and ⅜" female square drive adapter

LCD display with clear target indication from colour changing display (Plus version only). Visible in poorly lit work areas

Requires two Hexagon Socket Head Cap Screws ISO 4762 - M6 - 8.8 to fix in position (not included)



Above target tolerance



Within target tolerance



Below target tolerance



Requires two Hexagon Socket Head Cap Screws ISO 4762 - M10 - 12.9 to fix in position (not included)

TruCheck™ 2 Plus 350 N-m model shown with carry case, power supply and USB cable (with multinational plug adapter), quick reference (QR) guide and a calibration certificate.



Also available ¼" sq. dr. adaptor for 27mm male hexagon (29191) and 1" sq. dr. adaptor for 27mm male hexagon (29403)

KEY FEATURES

- Enables torque wrench performance to be monitored as part of your strategy to keep wrenches in peak condition
- Two versions, TruCheck™ 2 and TruCheck™ 2 Plus available
- 'Basic' version has limited settable options. Ideal for non-expert users with click type torque wrenches
- TruCheck™ 2 Plus allows a selection of torque units, three modes of operation (Click, Dial and Track), the ability to store up to 15 targets and select from 12 languages
- Plus version allows operator to set a target value and tolerance
- ±1% of reading accuracy (±2% when below 10% of range for the 10 N-m and 1,100 N-m TruCheck™ 2 model)
- Inbuilt Micro USB 2.0 port enables power from any USB power source. Plus version allows for both power and data transfer simultaneously
- Supplied with traceable calibration certificate in clockwise direction. A counter-clockwise calibration is available at additional cost
- A UKAS accredited calibration certificate can be provided in place of the traceable calibration certificate at additional cost

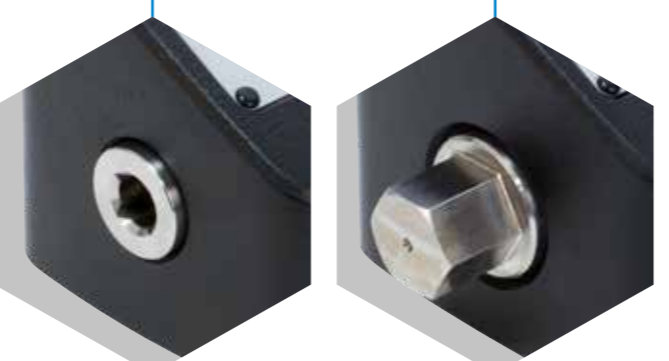

65 N-m models supplied with ⅜" female square drive
 260 lbf-ft and 350 N-m models supplied with ½" female square drive



800 lbf-ft and 1,100 N-m models supplied with 27 mm male hexagon plus ¼" square drive socket
 2,100 N-m models supplied with 27 mm male hexagon plus 1" square drive socket

